

# EXPRESS DELIVERY PRODUCTS GUIDE

2025

ARROW  
GROUP



formetiq®

MH METALICON®

# formetiq®

Our Formetiq® range of office furniture includes: desking, height adjustable desks, meeting and conference tables, acoustic screens, storage, task and meeting chairs and more.

# narbutas

Narbutas design and manufacture durable and functional furniture for the modern workspace. As Narbutas' largest accredited partner-distributor, we bring unique product expertise and unrivalled service to every project.

# ML METALICON®

Our Metalicon® range of ergonomic accessories includes: static and dynamic monitor arms, CPU holders, cable management and a choice of power modules: on-surface, in-surface and under-surface.



**FREE DELIVERY**  
on Metalicon® products\*

Work happy. Work well.  
**Join our dealer network**

Arrow stock and sell three brands of workspace furniture and accessories exclusively to the trade so we never compete with our dealers.

Your business is our business, so we strive to provide you with sales leads and extensive support. Some of our sales and support staff come from a dealer background, so we can empathise with your challenges.

### GUARANTEED RESULTS



Arrow Group now offer a 10 year\* manufacturer warranty on Formetiq® and Metalicon® products within this Express Delivery Guide.

Narbutas offer a 10 year\*\* manufacturer warranty on some of their products.

### REASSURING QUALITY

As well as being incredible value for money, all Formetiq® and Metalicon® products conform to relevant European or British manufacturing standards.

All our timber products are Rainforest Alliance, FSC or similarly accredited. The majority of our Metalicon® packaging is made using plastic-free recycled materials, look out for the Ocean Friendly logo on our accessories products when they arrive.



## CONTENTS

### DESKS

Bench Desking	04–09
Cantilever Desks	14
Height Adjustable Desks	10–13
Panel Leg Desks	14

### TABLES

Meeting Tables	15–17
----------------	-------

### STORAGE

MFC Pedestals	18
Steel Pedestals	19

### SEATING

Task Chairs	20–29
Meeting Chairs	30–35

### ACCESSORIES

Cable Management	40–43
Cables	49
Computer Mounts	50–51
Monitor Arms	36–39
Power	44–48

\* Terms, conditions and exclusions apply. \* 5 years on stacking chairs, seating components including controls, adjustable and height adjustable mechanisms, gas lifts and electrical items.

\*\* 5 years on drawers, sliding and tambour doors, work surfaces, foam parts, upholstery materials (fabric, textile).



### TRY OUR INSTALL TEAMS

Did you know Arrow Group have our own full time directly employed installation teams? Highly trained and skilled, we offer a comprehensive service including installation of other manufacturers' products alongside our own. For an effective solution to eliminate third parties and extra suppliers, why not ask us for an install quote on your next order?

## Ready to go!

Did you know we have up to £10 million of stock in our own warehouses all available to you for express delivery, mostly on our own vehicles?

**This handy guide makes it easy for you to select products required rapidly or on a guaranteed delivery date – our warehouse team love hitting a deadline!**

Look out for this blue logo for product specific lead times. Sometimes we may even be able to deliver next day – just ask our amazing business support team!



Contact our team today to discuss your requirements:

01502 533 433

[sales@arrowgroup.com](mailto:sales@arrowgroup.com)

### REGISTER FOR OUR ONLINE DEALER PORTAL

3D Product Configurator  
Nett prices with dealer discount applied  
Export product ranges to spreadsheets  
Live Stock Feed  
Dealer resources: technical, images, CAD

[portal.arrowgroup.com/register](https://portal.arrowgroup.com/register)

# SYSTEM

Single desks + modesty panels



Single starter desks - scoop back



Single desk extension - scoop back

CODE	SINGLE	WIDTH	DEPTH	HEIGHT	TOP MFC FINISH	LEG FINISH	RSP (£)
DSD-120-70-S	Scoop back desk	1200	700	740	White (KW) / Urban Oak (AO)	White (WH) / Black (BK)	536
DSD-140-70-S	Scoop back desk	1400	700	740	White (KW) / Urban Oak (AO)	White (WH) / Black (BK)	561
DSD-120-80-S	Scoop back desk	1200	800	740	White (KW) / Urban Oak (AO)	White (WH) / Black (BK)	532
DSD-140-80-S	Scoop back desk	1400	800	740	White (KW) / Urban Oak (AO)	White (WH) / Black (BK)	568
DSD-160-80-S	Scoop back desk	1600	800	740	White (KW) / Urban Oak (AO)	White (WH) / Black (BK)	593
DSE-120-70-S	Scoop back extension	1200	700	740	White (KW) / Urban Oak (AO)	White (WH) / Black (BK)	451
DSE-140-70-S	Scoop back extension	1400	700	740	White (KW) / Urban Oak (AO)	White (WH) / Black (BK)	476
DSE-120-80-S	Scoop back extension	1200	800	740	White (KW) / Urban Oak (AO)	White (WH) / Black (BK)	454
DSE-140-80-S	Scoop back extension	1400	800	740	White (KW) / Urban Oak (AO)	White (WH) / Black (BK)	490
DSE-160-80-S	Scoop back extension	1600	800	740	White (KW) / Urban Oak (AO)	White (WH) / Black (BK)	515

CODE	MODESTY PANELS	WIDTH	DEPTH	HEIGHT	MFC FINISH	BRACKETS FINISH	RSP (£)
DMP-120	For W1200 desk	1097	25	300	White (KW) / Urban Oak (AO)	White (WH) / Black (BK)	68
DMP-140	For W1400 desk	1297	25	300	White (KW) / Urban Oak (AO)	White (WH) / Black (BK)	79
DMP-160	For W1600 desk	1497	25	300	White (KW) / Urban Oak (AO)	White (WH) / Black (BK)	89

CODE	CABLE TRAYS	WIDTH	DEPTH	HEIGHT	FINISH	RSP (£)
DSCT-100	For W1200 / 1400 desk	1000	443	120	White (WH) / Black (BK)	100
DSCT-140	For W1600 desk	1400	443	120	White (WH) / Black (BK)	120

## FEATURES

Neutral and contemporary look with 10mm shadow gap between top and frame

Modular and adaptable

Recessed shared leg extensions

Robust frame construction

Easy install cable trays fix to frame for back-to-back

50mm central gap for back-to-back

Discreet adjustable levelling feet (10mm)

Easy to assemble / disassemble with threaded fixing points, can be safely reassembled

Scoop back desktops  
Allow for cable management

[Find cable management on pages 40-43](#)

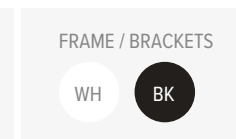
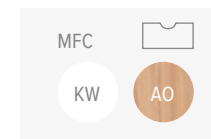

# SYSTEM

Back-to-back bench desks

DELIVERED IN  
3-5 DAYS 



Back-to-back starter desks - scoop back



Back-to-back extension desks - scoop back

## FEATURES

Neutral and contemporary look with 10mm shadow gap between top and frame

Modular and adaptable

Recessed shared leg extensions

Robust frame construction

Easy install cable trays fix to frame for back-to-back

50mm central gap for back-to-back

Discreet adjustable levelling feet (10mm)

Easy to assemble / disassemble with threaded fixing points, can be safely reassembled

Scoop back desktops  
Allow for cable management

[Find cable management on pages 40-43](#)

CODE	B2B BENCH	WIDTH	DEPTH	HEIGHT	TOP MFC FINISH	LEG FINISH	RSP (£)
DBD-120-70-S	Scoop back bench	1200	1450	740	White (KW) / Urban Oak (AO)	White (WH) / Black (BK)	845
DBD-140-70-S	Scoop back bench	1400	1450	740	White (KW) / Urban Oak (AO)	White (WH) / Black (BK)	895
DBD-120-80-S	Scoop back bench	1200	1650	740	White (KW) / Urban Oak (AO)	White (WH) / Black (BK)	857
DBD-140-80-S	Scoop back bench	1400	1650	740	White (KW) / Urban Oak (AO)	White (WH) / Black (BK)	929
DBD-160-80-S	Scoop back bench	1600	1650	740	White (KW) / Urban Oak (AO)	White (WH) / Black (BK)	979
DBE-120-70-S	Scoop back extension	1200	1450	740	White (KW) / Urban Oak (AO)	White (WH) / Black (BK)	792
DBE-140-70-S	Scoop back extension	1400	1450	740	White (KW) / Urban Oak (AO)	White (WH) / Black (BK)	842
DBE-120-80-S	Scoop back extension	1200	1650	740	White (KW) / Urban Oak (AO)	White (WH) / Black (BK)	808
DBE-140-80-S	Scoop back extension	1400	1650	740	White (KW) / Urban Oak (AO)	White (WH) / Black (BK)	880
DBE-160-80-S	Scoop back extension	1600	1650	740	White (KW) / Urban Oak (AO)	White (WH) / Black (BK)	930

CODE	SHARED CABLE TRAYS	WIDTH	DEPTH	HEIGHT	FINISH	RSP (£)
DBCT-100	For W1200 / 1400 bench	1000	443	120	White (WH) / Black (BK)	129
DBCT-140	For W1600 bench	1400	443	120	White (WH) / Black (BK)	165



MFC

KW

AO

FRAME / BRACKETS

WH

BK

# SYSTEM

Desk height storage + planters

DELIVERED IN  
3-5 DAYS 



Bookcase

Cupboard

Sliding Door Cupboard

CODE	BOOKCASES	WIDTH	DEPTH	MFC FINISH	RSP (€)
SBC-070-2	Bookcase, 2 levels	700	400	White (KW) / Urban Oak (AO)	217
SBC-080-2		800	400	White (KW) / Urban Oak (AO)	231
SBC-145-2		1450	400	White (KW) / Urban Oak (AO)	383
SBC-165-2		1650	400	White (KW) / Urban Oak (AO)	416

CODE	CUPBOARDS	WIDTH	DEPTH	MFC FINISH	SQUARE BLOCK HANDLE FINISH	RSP (€)
SCH-070-2	Cupboard	700	400	White (KW) / Urban Oak (AO)	White (BWH) / Nickel (BBN) / Black (BBK)	291
SCH-080-2		800	400	White (KW) / Urban Oak (AO)	White (BWH) / Nickel (BBN) / Black (BBK)	313
SCH-145-2		1450	400	White (KW) / Urban Oak (AO)	White (BWH) / Nickel (BBN) / Black (BBK)	618
SCH-165-2		1650	400	White (KW) / Urban Oak (AO)	White (BWH) / Nickel (BBN) / Black (BBK)	662
SCB-070-2	Lockable Cupboard	700	400	White (KW) / Urban Oak (AO)	White (BWH) / Nickel (BBN) / Black (BBK)	355
SCB-080-2		800	400	White (KW) / Urban Oak (AO)	White (BWH) / Nickel (BBN) / Black (BBK)	377
SCB-145-2		1450	400	White (KW) / Urban Oak (AO)	White (BWH) / Nickel (BBN) / Black (BBK)	746
SCB-165-2		1650	400	White (KW) / Urban Oak (AO)	White (BWH) / Nickel (BBN) / Black (BBK)	790
SSH-145-2	Sliding Door Cupboard	1450	400	White (KW) / Urban Oak (AO)	White (BWH) / Nickel (BBN) / Black (BBK)	560
SSH-165-2		1650	400	White (KW) / Urban Oak (AO)	White (BWH) / Nickel (BBN) / Black (BBK)	608
SSB-145-2	Lockable Sliding Door Cupboard	1450	400	White (KW) / Urban Oak (AO)	White (BWH) / Nickel (BBN) / Black (BBK)	597
SSB-165-2		1650	400	White (KW) / Urban Oak (AO)	White (BWH) / Nickel (BBN) / Black (BBK)	645

## FEATURES

Mix and match external and internal finish (bookcases)

Mix and match carcass and door finish (cupboard)

In-frame style, with 25mm top, base and sides

Lockable cupboard doors available

Square block handles in matt white, matt black or brushed nickel

Alternative handle styles and finishes available on standard factory lead times

Supplied flat pack with knock down fixings

Easy to assemble with international (wordless) instructions



MFC

KW

AO

HANDLES

BWH

BBN

BBK

DELIVERED IN  
3-5 DAYS



Planter with liner

FEATURES

Planters available to match all storage widths

Robust waterproof fibreglass planter liners  
Can be dropped into planters after installation

CODE	PLANTERS	WIDTH	DEPTH	HEIGHT	MFC FINISH	RSP (£)
SPL-070	Planter with liner	700	400	200	White (KW) / Urban Oak (AO)	331
SPL-080		800	400	200	White (KW) / Urban Oak (AO)	338
SPL-145		1450	400	200	White (KW) / Urban Oak (AO)	638
SPL-165		1650	400	200	White (KW) / Urban Oak (AO)	671
SPN-070	Planter	700	400	200	White (KW) / Urban Oak (AO)	123
SPN-080		800	400	200	White (KW) / Urban Oak (AO)	130
SPN-145		1450	400	200	White (KW) / Urban Oak (AO)	214
SPN-165		1650	400	200	White (KW) / Urban Oak (AO)	221

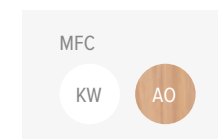

# SYSTM

Acoustic screens + brackets

DELIVERED IN  
14 DAYS 



Single desk / in-line bench screen



Back-to-back bench spine screen



Centre return screen



End return screen

## FEATURES

**Upholstered in a wide range of fabrics**

### Double-sided fabrics

Different fabrics can be specified for each side of the screen, providing greater creative design opportunities

**All brackets supplied with screens**

**Align tops of screens between SYSTM fixed height desks and Alto height adjustable benches**  
H600mm SYSTM screens with H700mm Alto screens

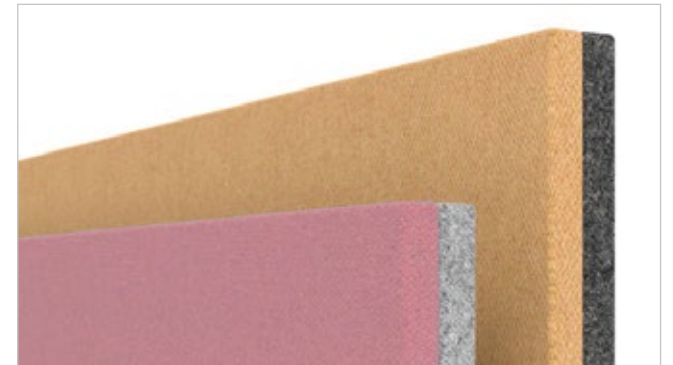

BRACKETS

WH

BK



CODE	ACOUSTIC SCREENS	WIDTH	HEIGHT	BRACKETS FINISH	G1 (£)	G2 (£)	G3 (£)	G4 (£)
SSS-12-05	Single desk screen + brackets	1200	500 (475)	White (WH) / Black (BK)	272	307	376	445
SSS-14-05		1400	500 (475)	White (WH) / Black (BK)	277	312	381	450
SSS-16-05		1600	500 (475)	White (WH) / Black (BK)	296	330	399	468
SSS-12-06		1200	600 (575)	White (WH) / Black (BK)	286	323	398	473
SSS-14-06		1400	600 (575)	White (WH) / Black (BK)	300	340	420	501
SSS-16-06		1600	600 (575)	White (WH) / Black (BK)	313	353	434	514
SSD-12-05	Bench spine screen + brackets	1200	500 (475)	White (WH) / Black (BK)	268	303	372	441
SSD-14-05		1400	500 (475)	White (WH) / Black (BK)	273	308	377	446
SSD-16-05		1600	500 (475)	White (WH) / Black (BK)	292	326	395	464
SSD-12-06		1200	600 (575)	White (WH) / Black (BK)	282	319	394	469
SSD-14-06		1400	600 (575)	White (WH) / Black (BK)	296	336	416	497
SSD-16-06		1600	600 (575)	White (WH) / Black (BK)	309	349	430	510
SRC-07-05	Centre return screen + brackets	700	472 (475)	White (WH) / Black (BK)	212	229	263	298
SRC-08-05		800	472 (475)	White (WH) / Black (BK)	241	267	318	370
SRC-07-06		700	572 (575)	White (WH) / Black (BK)	218	235	269	304
SRC-08-06		800	572 (575)	White (WH) / Black (BK)	244	270	322	374
SRE-07-05	End return screen + brackets	700	472 (475)	White (WH) / Black (BK)	210	227	261	296
SRE-08-05		800	472 (475)	White (WH) / Black (BK)	239	265	316	368
SRE-07-06		700	572 (575)	White (WH) / Black (BK)	216	233	267	302
SRE-08-06		800	572 (575)	White (WH) / Black (BK)	242	268	320	372

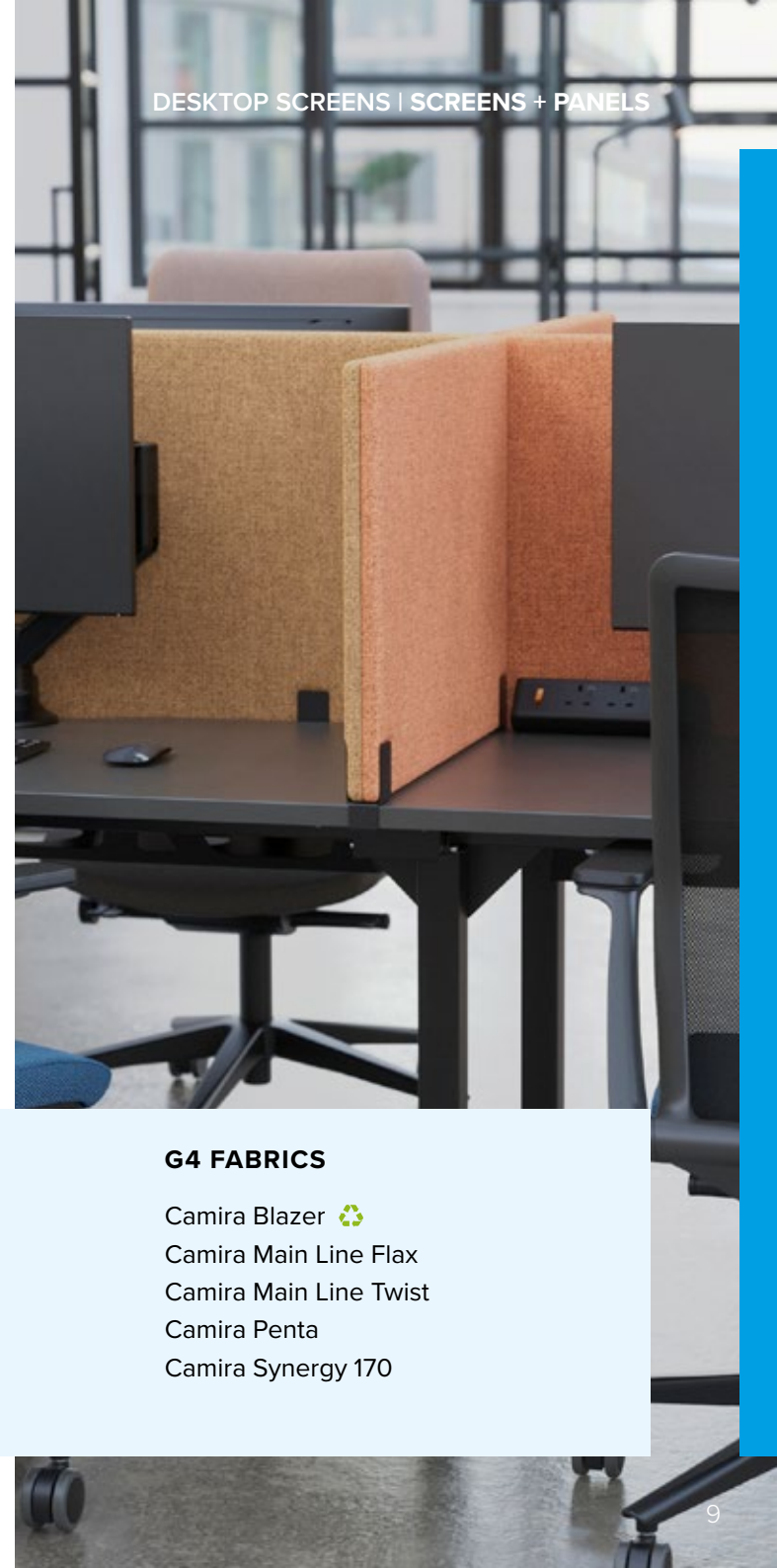

**G1 FABRICS**

- Camira Cara
- Camira Carlow
- Camira Era 170

Sustainable / natural

**G2 FABRICS**

- Camira Era
- Camira Gravity
- Camira Lucia
- Camira Sonus

**G3 FABRICS**

- Camira Blazer Lite
- Camira Quest
- Camira RePlay
- Camira Urban
- Camira X2

**G4 FABRICS**

- Camira Blazer
- Camira Main Line Flax
- Camira Main Line Twist
- Camira Penta
- Camira Synergy 170

# Alto 1 Standing desk

Single motor 2 stage frame

DELIVERED IN  
3-5\* DAYS 



## FEATURES

### Scoop back desktops

Allow for cable management

### 2-stage reversed rectangular columns with single motor

### Easy-to-use control panel for desk height adjustment

### Smooth and quiet height adjustment

### Height range: 710–1210mm

### Motor speed: 25mm/s

### Max load: 70kg

### Width adjustment: 1000–1600mm

Desk frames will accommodate a range of desktop sizes and styles

### Desktop depth capacity: 700–800mm

### Advanced anti-collision system with adjustable sensitivity prevents contact with objects beneath desk during height adjustment

If an obstacle is detected the motor instantly stops and reverses.

### Easy to assemble

[Find cable management on pages 40-43](#)

[Find screen fabric price groups on page 9](#)

CODE	ALTO 1 DESK BUNDLE	WIDTH	DEPTH	HEIGHT	TOP MFC FINISH	FRAME FINISH	RSP (€)
H1S47S	Desk frame + Scoop desktop	1400	700	710-1210	White (KW) / Urban Oak (AO)	White (WH) / Grey (SV) / Black (BK)	885
H1S28S	Desk frame + Scoop desktop	1200	800	710-1210	White (KW) / Urban Oak (AO)	White (WH) / Grey (SV) / Black (BK)	863
H1S48S	Desk frame + Scoop desktop	1400	800	710-1210	White (KW) / Urban Oak (AO)	White (WH) / Grey (SV) / Black (BK)	890
H1S68S	Desk frame + Scoop desktop	1600	800	710-1210	White (KW) / Urban Oak (AO)	White (WH) / Grey (SV) / Black (BK)	901

CODE	DESK FRAME	DESKTOP WIDTH CAPACITY	DESKTOP DEPTH CAPACITY	FRAME FINISH	RSP (€)
HAFS121	Alto 1 desk frame only	1000-1600	700–800	White (WH) / Grey (SV) / Black (BK)	689

CODE	FABRIC SCREENS	WIDTH	HEIGHT	BRACKETS FINISH	G1 (€)	G2 (€)	G3 (€)	G4 (€)
SSA-12-08	Alto 1 desk screen + brackets	1200	800	White (WH) / Grey (SV) / Black (BK)	351	403	507	610
SSA-14-08	Alto 1 desk screen + brackets	1400	800	White (WH) / Grey (SV) / Black (BK)	358	410	513	616
SSA-16-08	Alto 1 desk screen + brackets	1600	800	White (WH) / Grey (SV) / Black (BK)	407	458	562	665

MFC TOP 

KW

AO

FRAME

WH

SV

BK

Alternative desktop styles, including straight back, and alternative MFC finishes are available on standard factory lead times

\* Fabric screens delivered in 14 days

# Alto 1 Standing bench

Back-to-back 2 stage frames



## FEATURES

### Scoop back desktops

Allow for cable management

### 2-stage reversed rectangular columns with single motor

### Easy-to-use control panels for desk height adjustment

### Smooth and quiet height adjustment

Height range: 710–1210mm

Motor speed: 25mm/s

Max load: 70kg

Width adjustment: 1000–1600mm

Desk frames will accommodate a range of desktop sizes and styles

Desktop depth capacity: 700–800mm

Advanced anti-collision system with adjustable sensitivity prevents contact with objects beneath desk during height adjustment

If an obstacle is detected the motor instantly stops and reverses.

### Easy to assemble

[Find cable management on pages 40-43](#)

[Find screen fabric price groups on page 9](#)

CODE	ALTO 1 B2B BUNDLE	WIDTH	DEPTH	HEIGHT	TOP MFC FINISH	FRAME FINISH	RSP (£)
H1B47S	B2B desks + Scoop desktops	1400	1450	710-1210	White (KW) / Urban Oak (AO)	White (WH) / Grey (SV) / Black (BK)	1873
H1B28S	B2B desks + Scoop desktops	1200	1650	710-1210	White (KW) / Urban Oak (AO)	White (WH) / Grey (SV) / Black (BK)	1829
H1B48S	B2B desks + Scoop desktops	1400	1650	710-1210	White (KW) / Urban Oak (AO)	White (WH) / Grey (SV) / Black (BK)	1883
H1B68S	B2B desks + Scoop desktops	1600	1650	710-1210	White (KW) / Urban Oak (AO)	White (WH) / Grey (SV) / Black (BK)	1905

CODE	BENCH FRAMES	DESKTOP WIDTH CAPACITY	DESKTOP DEPTH CAPACITY	FRAME FINISH	RSP (£)
HAFD121	2-desk back-to-back frames	1000-1600	700–800	White (WH) / Grey (SV) / Black (BK)	1481

CODE	FABRIC SCREENS	WIDTH	HEIGHT	BRACKETS FINISH	G1 (£)	G2 (£)	G3 (£)	G4 (£)
SS1-12-07	Alto 1 bench screen + brackets	1200	800	White (WH) / Grey (SV) / Black (BK)	333	370	445	520
SS1-14-07	Alto 1 bench screen + brackets	1400	800	White (WH) / Grey (SV) / Black (BK)	350	393	479	565
SS1-16-07	Alto 1 bench screen + brackets	1600	800	White (WH) / Grey (SV) / Black (BK)	410	456	548	640

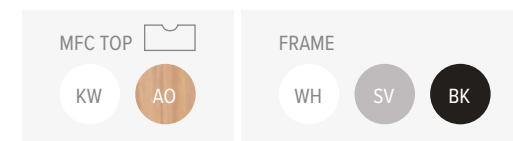

Alternative desktop styles, including straight back, and alternative MFC finishes are available on standard factory lead times

\*Fabric screens delivered in 14 days

# Alto 2 Standing desk

Twin motor 3 stage frame

DELIVERED IN  
3-5\* DAYS 



## FEATURES

**3 stage holeless square columns with twin motors**

**Width adjustment: 1100–1900mm**

Desk frames will accommodate a range of desktop sizes and styles

**Scoop back desktops allow for cable management**

**Height range: 580–1230mm**

**Fast and smooth height adjustment - no juddering**

Motor speed: 38mm/s

**Max. load: 125kg**

**Integrated cable tidy**

**Programmable control panel**

3 height memory presets, digital height display and reminder timer function

**Ultra-quiet motors (lower than 50dB)**

**Advanced anti-collision system with adjustable sensitivity prevents contact with objects beneath desk during height adjustment**

If an obstacle is detected the motor instantly stops and reverses

**Easy to assemble**

[Find cable management on pages 40-43](#)

[Find fabric price groups on page 9](#)

CODE	ALTO 2 DESK BUNDLE	WIDTH	DEPTH	HEIGHT	TOP MFC FINISH	FRAME FINISH	RSP (£)
H2S47S	Desk frame + Scoop desktop	1400	700	580-1230	White (KW) / Urban Oak (AO)	White (WH) / Black (BK)	1283
H2S28S	Desk frame + Scoop desktop	1200	800	580-1230	White (KW) / Urban Oak (AO)	White (WH) / Black (BK)	1261
H2S48S	Desk frame + Scoop desktop	1400	800	580-1230	White (KW) / Urban Oak (AO)	White (WH) / Black (BK)	1288
H2S68S	Desk frame + Scoop desktop	1600	800	580-1230	White (KW) / Urban Oak (AO)	White (WH) / Black (BK)	1299

CODE	DESK FRAME	DESKTOP WIDTH CAPACITY	DESKTOP DEPTH CAPACITY	FRAME FINISH	RSP (£)
HAFS233	Alto 2 desk frame only	1100-1900	700–800	White (WH) / Black (BK)	1087

CODE	FABRIC SCREENS	WIDTH	HEIGHT	BRACKETS FINISH	G1 (£)	G2 (£)	G3 (£)	G4 (£)
SSA-12-08	Alto 2 desk screen + brackets	1200	800	White (WH) / Black (BK)	351	403	507	610
SSA-14-08	Alto 2 desk screen + brackets	1400	800	White (WH) / Black (BK)	358	410	513	616
SSA-16-08	Alto 2 desk screen + brackets	1600	800	White (WH) / Black (BK)	407	458	562	665

MFC TOP 

KW

AO

FRAME

WH

BK

Alternative desktop styles, including straight back, and alternative MFC finishes are available on standard factory lead times

\* Fabric screens delivered in 14 days

# Alto 2 Standing bench

Twin motor 3 stage back-to-back frame



CODE	ALTO 2 BENCH BUNDLE	WIDTH	DEPTH	HEIGHT	TOP MFC FINISH	FRAME FINISH	RSP (£)
H2B47S	B2B Frame + Scoop Desktops	1400	1450	580-1230	White (KW) / Urban Oak (AO)	White (WH) / Black (BK)	2680
H2B28S	B2B Frame + Scoop Desktops	1200	1650	580-1230	White (KW) / Urban Oak (AO)	White (WH) / Black (BK)	2636
H2B48S	B2B Frame + Scoop Desktops	1400	1650	580-1230	White (KW) / Urban Oak (AO)	White (WH) / Black (BK)	2690
H2B68S	B2B Frame + Scoop Desktops	1600	1650	580-1230	White (KW) / Urban Oak (AO)	White (WH) / Black (BK)	2712

CODE	BENCH FRAME	DESKTOP WIDTH CAPACITY	DESKTOP DEPTH CAPACITY	FRAME FINISH	RSP (£)
HAFD233	Alto 2 bench frame only	1100-1900	700-800	White (WH) / Black (BK)	2288

White (WH) / Black (BK)

CODE	OPTIONAL	BRACKETS FINISH	RSP (£)
HAFD2-CT	Adjustable shared central cable tray with sliding lid (D230 x H80mm)	White (WH) / Black (BK)	286
HAFD2-SB	Pair of brackets (2 pcs.) to mount universal screen between desktops on Alto 2 bench	White (WH) / Black (BK)	50

CODE	FABRIC SCREENS	WIDTH	HEIGHT	BRACKETS FINISH	G1 (£)	G2 (£)	G3 (£)	G4 (£)
SS2-12-07	Alto 2 bench screen + brackets	1200	800	White (WH) / Black (BK)	339	376	451	526
SS2-14-07	Alto 2 bench screen + brackets	1400	800	White (WH) / Black (BK)	356	399	485	571
SS2-16-07	Alto 2 bench screen + brackets	1600	800	White (WH) / Black (BK)	416	462	554	646

## FEATURES

**3 stage holeless square columns with twin motors**  
Stable frame design with cross beams

**Width adjustment: 1100–1900mm**  
Desk frames will accommodate a range of desktop sizes and styles

**Scoop back desktops allow for cable management**

**Height range: 580–1230mm**

**Fast and smooth height adjustment - no juddering**  
Motor speed: 38mm/s

**Max. load: 125kg**

**Programmable control panels**  
3 height memory presets, digital height display and reminder timer function

**Ultra-quiet motors (lower than 50dB)**

**Advanced anti-collision system with adjustable sensitivity prevents contact with objects beneath desk during height adjustment**  
If an obstacle is detected the motor instantly stops and reverses

**Adjustable shared cable tray with sliding lid (optional)**

[Find cable management on pages 40-43](#)

[Find fabric price groups on page 9](#)

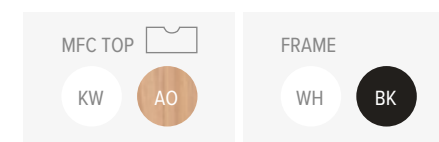

# Optima C + Optima Plus

Cantilever + panel leg desks

DELIVERED IN  
3-5 DAYS 



## FEATURES

25mm MFC desktop and modesty panel

Left and right round cable ports

[Find cable management on pages 40-43](#)

[Find cable port power on page 46](#)



CODE	OPTIMA C DESKS	WIDTH	DEPTH	HEIGHT	TOP FINISH	FRAME FINISH	RSP (£)
DCA121	Cantilever Desk	1200	800	720	White (PA01) / Amber Oak (PA07)	White (MA03) / Grey (MA02)	374
DCA141	Cantilever Desk	1400	800	720	White (PA01) / Amber Oak (PA07)	White (MA03) / Grey (MA02)	396
DCA161	Cantilever Desk	1600	800	720	White (PA01) / Amber Oak (PA07)	White (MA03) / Grey (MA02)	432

CODE	OPTIMA PLUS DESKS	WIDTH	DEPTH	HEIGHT	FINISH	RSP (£)
DDA121	Panel Leg Desk	1200	800	720	White (PA01) / Amber Oak (PA07)	328
DDA141	Panel Leg Desk	1400	800	720	White (PA01) / Amber Oak (PA07)	350
DDA161	Panel Leg Desk	1600	800	720	White (PA01) / Amber Oak (PA07)	386

MFC	LEGS / FRAME
<div style="display: flex; gap: 10px;"> <div style="border: 1px solid grey; border-radius: 50%; width: 20px; height: 20px; display: flex; align-items: center; justify-content: center;">PA01</div> <div style="border: 1px solid grey; border-radius: 50%; width: 20px; height: 20px; display: flex; align-items: center; justify-content: center;">PA07</div> </div>	<div style="display: flex; gap: 10px;"> <div style="border: 1px solid grey; border-radius: 50%; width: 20px; height: 20px; display: flex; align-items: center; justify-content: center;">MA03</div> <div style="border: 1px solid grey; border-radius: 50%; width: 20px; height: 20px; display: flex; align-items: center; justify-content: center;">MA02</div> </div>

# SYSTM

Meeting tables

DELIVERED IN  
3-5 DAYS 



Meeting table, single piece top



Long meeting table, single piece top



Extra deep starter table



Extra deep table extension

## FEATURES

Neutral and contemporary look with 10mm shadow gap between top and frame

Modular and adaptable

Recessed shared leg extensions

Robust frame construction

Easy install cable trays fix to frame for back-to-back

Discreet adjustable levelling feet (10mm)

Easy to assemble / disassemble with threaded fixing points, can be safely reassembled

[Find cable management on pages 40-43](#)

CODE	MEETING TABLES	WIDTH	DEPTH	HEIGHT	MFC FINISH	LEG FINISH	RSP (£)
DMS-160-100	Meeting table	1600	1000	740	White (KW) / Urban Oak (AO)	White (WH) / Black (BK)	618
DMS-160-125	Meeting table	1600	1250	740	White (KW) / Urban Oak (AO)	White (WH) / Black (BK)	811
DMS-200-125	Meeting table	2000	1250	740	White (KW) / Urban Oak (AO)	White (WH) / Black (BK)	896
DME-160-125	Table extension	1600	1250	740	White (KW) / Urban Oak (AO)	White (WH) / Black (BK)	754
DME-200-125	Table extension	2000	1250	740	White (KW) / Urban Oak (AO)	White (WH) / Black (BK)	839
DMS-240-125	Long meeting table	2400	1250	740	White (KW) / Urban Oak (AO)	White (WH) / Black (BK)	1374
DMS-160-165	Deep meeting table	1600	1650	740	White (KW) / Urban Oak (AO)	White (WH) / Black (BK)	985
DME-160-165	Deep table extension	1600	1650	740	White (KW) / Urban Oak (AO)	White (WH) / Black (BK)	936

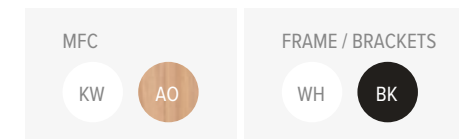

# T-Easy

Meeting tables

DELIVERED IN  
3-5 DAYS 



## FEATURES

Central cut-out cable port for cable management

Ideal for 3 to 8 people

T-shaped legs provide more space underneath

Use with Narbutas Media conference walls

[Find cable management on pages 40-43](#)

CODE	T-EASY MEETING TABLES	WIDTH	DEPTH	HEIGHT	TOP MFC FINISH	LEG FINISH - TYPE 'I'	RSP (£)
DZM202.PA01.MA03.I	Rectangular with cable port*	2000	1200	740	White (PA01)	White (MA03)	<b>936</b>
DZM242.PA01.MA03.I	Rectangular with cable port*	2400	1200	740	White (PA01)	White (MA03)	<b>1065</b>
G6F0147.MA03	Cable port insert	320	130	25	-	White (MA03)	<b>99</b>

MFC TOP

PA01

LEGS

MA03

\* Requires G6F0147 cable port insert  
Alternative MFC finishes are available on standard factory lead times



# Forum

Round meeting tables



## FEATURES

Single column leg provides more space underneath and avoids legs obstructing chairs

Ideal for 3 to 6 people

CODE	FORUM ROUND TABLES	TOP	HEIGHT	TOP MFC FINISH	METAL BASE FINISH	RSP (£)
COM080	Round table with metal base	Ø800	740	White (PA01) / Amber Oak (PA07)	White (MA03) / Grey (MA02) / Black (MA01)	<b>843</b>
COM090	Round table with metal base	Ø900	740	White (PA01) / Amber Oak (PA07)	White (MA03) / Grey (MA02) / Black (MA01)	<b>968</b>
COM100	Round table with metal base	Ø1000	740	White (PA01) / Amber Oak (PA07)	White (MA03) / Grey (MA02) / Black (MA01)	<b>986</b>
COM120	Round table with metal base	Ø1200	740	White (PA01) / Amber Oak (PA07)	White (MA03) / Grey (MA02) / Black (MA01)	<b>1052</b>

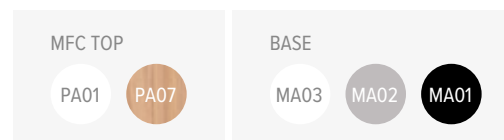

# Optima

MFC storage pedestal

DELIVERED IN  
3-5 DAYS 



## FEATURES

White foil wrapped wooden drawer sides

Central locking

16mm MFC with 1mm ABS edging

2 standard drawers

Castors

Box file drawer

CODE	OPTIMA	WIDTH	DEPTH	HEIGHT	MFC FINISH	HANDLES FINISH - TYPE 'X'	RSP (£)
G1A0207	MFC Pedestal	415	500	638	White (PA01) / Amber Oak (PA07)	White (MA03X) / Grey (MA02X) / Black (MA01X)	370

MFC

M1

D2

HANDLES

MA03X

MA02X

MA01X

# Cube

Steel mobile storage pedestals

DELIVERED IN  
3-5 DAYS 



Narrow width



Classic width

## FEATURES

2 drawers + full box file drawer  
Soft close drawer runners

Drawer dividers and pen tray included

Central locking

Solid steel construction

Pre-assembled hidden locking castors

Slim top and flat front design

Supplied assembled

Certified to: BS EN 14073 - 2&3:2004

**FIRA**

CODE	CUBE PEDESTALS	WIDTH	DEPTH	HEIGHT	FINISH	RSP (£)
PMS3521	Narrow pedestal - 2 drawers + 1 file drawer	300	500	597	White (WH) / Grey (SV) / Black (BK)	337
PMS4521	Classic pedestal - 2 drawers + 1 file drawer	410	500	597	White (WH) / Grey (SV) / Black (BK)	358

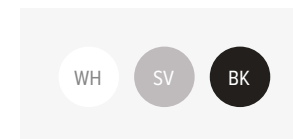

# Veneto

Mesh back task chair

DELIVERED IN  
10 DAYS 



## FEATURES

Self-balance mech with 2 locking positions

Distinctive angled backrest

Adjustable lumbar support

Mesh backrest offers flexibility and breathability

Sliding seat for seat depth adjustment (optional)

Height adjustable padded armrests (optional)

Black or polished 5-star base with soft floor castors

Chairs upholstered in alternative Camira fabric can normally be delivered within 14 days!

CODE	MECHANISM	EXTRAS	FINISH	FABRIC	RSP (£)
NMB-G0	Self-balance mech with 2 locking positions	No armrests	Black frame / mesh Black base / gas lift	Black	<b>394</b>
NMB1-G0	Self-balance mech with 2 locking positions	Height adjustable armrests	Black frame / mesh Black base / gas lift	Black	<b>437</b>

SUFFIX	OPTIONAL EXTRAS	RSP (£)
-P	Swap to polished aluminium 5-star base	<b>+39</b>
-C	Swap to hard floor castors	<b>+0</b>

CODE CHANGE EXAMPLES	
+ Polished base	<b>NMB-P-G0</b>
+ Polished base + Hard floor castors	<b>NMB-PC-G0</b>

BK

# Veneto Executive

Mesh back task chair

DELIVERED IN 10 DAYS 



## FEATURES

Synchro mech with 4 locking positions  
Easy to access side tension adjustment

Distinctive angled backrest

Height adjustable headrest

Adjustable lumbar support

Mesh backrest offers flexibility and breathability

Sliding seat for seat depth adjustment (optional)

Height adjustable padded armrests (optional)

Black or polished 5-star base with soft floor castors

Chairs upholstered in alternative Camira fabric can normally be delivered within 14 days!

CODE	MECHANISM	EXTRAS	FINISH	SEAT FABRIC	RSP (£)
NEB-G0	Synchro mech with 4 locking positions + Sliding seat	No armrests	Black frame / mesh Black base / gas lift	Black	457
NEB1-G0	Synchro mech with 4 locking positions + Sliding seat	Height adjustable armrests	Black frame / mesh Black base / gas lift	Black	500
NEB1H-G0	Synchro mech with 4 locking positions + Sliding seat	Adjustable headrest + Height adjustable armrests	Black frame / mesh Black base / gas lift	Black	531

SUFFIX	OPTIONAL EXTRAS	RSP (£)
-P	Swap to polished aluminium 5-star base	+39
-C	Swap to hard floor castors	+0

CODE CHANGE EXAMPLES	
+ Polished base	NEB-P-G0
+ Polished base + Hard floor castors	NEB-PC-G0

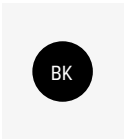

# Monza Mesh

Black

DELIVERED IN  
10 DAYS 



## FEATURES

Auto synchro mech with 4 locking positions  
Fine-tune side tension adjustment

Sliding seat for seat depth adjustment (optional)

Fixed armrests with adjustable soft pads (optional)  
Match frame colour

3D adjustable armrests with soft pads (optional)

Adjustable lumbar support

Mesh backrest offers flexibility and breathability

Distinctive angled backrest  
Black frame with black mesh

Black or polished 5-star base with soft floor castors

Chairs upholstered in alternative Camira fabric can normally be delivered within 14 days!

CODE	MECHANISM	EXTRAS	FINISH	SEAT FABRIC	RSP (£)
ZMB-PUK09	Automatic synchro mech with 4 locking positions	No armrests	Black frame / mesh Black base / gas lift	Camira Target Black	532
ZMBF-PUK09	Automatic synchro mech with 4 locking positions	Backrest mounted fixed height armrests with depth adjustable soft pads	Black frame / mesh Black base / gas lift	Camira Target Black	622
ZMB3-PUK09	Automatic synchro mech with 4 locking positions	Seat mounted 3D adjustable armrests with soft pads	Black frame / mesh Black base / gas lift	Camira Target Black	612
ZMB3H-PUK09	Automatic synchro mech with 4 locking positions	Seat mounted 3D adjustable armrests with soft pads + Mesh headrest	Black frame / mesh Black base / gas lift	Camira Target Black	700

SUFFIX	OPTIONAL EXTRAS	RSP (£)
-S	Swap to sliding seat	+66
-P	Swap to polished aluminium 5-star base	+107
-C	Swap to hard floor castors	+0

CODE CHANGE EXAMPLES	
+ Sliding seat	ZMB-S-[FABRIC]
+ Sliding seat + Polished base	ZMB-SP-[FABRIC]
+ Sliding seat + Polished base + Hard floor castors	ZMB-SPC-[FABRIC]

# Monza Mesh

Grey

DELIVERED IN  
10 DAYS 



## FEATURES

Auto synchro mech with 4 locking positions  
Fine-tune side tension adjustment

Sliding seat for seat depth adjustment (optional)

Fixed armrests with adjustable soft pads (optional)  
Match frame colour

3D adjustable armrests with soft pads (optional)

Adjustable lumbar support

Mesh backrest offers flexibility and breathability

Distinctive angled backrest  
Grey frame with grey mesh

Black or polished 5-star base with soft floor castors

Chairs upholstered in alternative Camira fabric can normally be delivered within 14 days!

CODE	MECHANISM	EXTRAS	FINISH	SEAT FABRIC	RSP (£)
ZMG-PUK09	Automatic synchro mech with 4 locking positions	No armrests	Grey frame / mesh Black base / gas lift	Camira Target Black	560
ZMGF-PUK09	Automatic synchro mech with 4 locking positions	Backrest mounted fixed height armrests with depth adjustable soft pads	Grey frame / mesh Black base / gas lift	Camira Target Black	665
ZMG3-PUK09	Automatic synchro mech with 4 locking positions	Seat mounted 3D adjustable armrests with soft pads	Grey frame / mesh Black base / gas lift	Camira Target Black	640

SUFFIX	OPTIONAL EXTRAS	RSP (£)
-S	Swap to sliding seat	+66
-P	Swap to polished aluminium 5-star base	+107
-C	Swap to hard floor castors	+0

CODE CHANGE EXAMPLES	
+ Sliding seat	ZMG-S-[FABRIC]
+ Sliding seat + Polished base	ZMG-SP-[FABRIC]
+ Sliding seat + Polished base + Hard floor castors	ZMG-SPC-[FABRIC]

# Monza Mesh

White



## FEATURES

Auto synchro mech with 4 locking positions  
Fine-tune side tension adjustment

Sliding seat for seat depth adjustment (optional)

Fixed armrests with adjustable soft pads (optional)  
Match frame colour

3D adjustable armrests with soft pads (optional)

Adjustable lumbar support

Mesh backrest offers flexibility and breathability

Distinctive angled backrest  
White frame with black mesh

Black or polished 5-star base with soft floor castors

Chairs upholstered in alternative Camira fabric can normally be delivered within 14 days!

CODE	MECHANISM	EXTRAS	FINISH	SEAT FABRIC	RSP (£)
ZMW-PUK09	Automatic synchro mech with 4 locking positions	No armrests	White frame + Black mesh Black base / gas lift	Camira Target Black	560
ZMWF-PUK09	Automatic synchro mech with 4 locking positions	Backrest mounted fixed height armrests with depth adjustable soft pads	White frame + Black mesh Black base / gas lift	Camira Target Black	665
ZMW3-PUK09	Automatic synchro mech with 4 locking positions	Seat mounted 3D adjustable armrests with soft pads	White frame + Black mesh Black base / gas lift	Camira Target Black	640

SUFFIX	OPTIONAL EXTRAS	RSP (£)
-S	Swap to sliding seat	+66
-P	Swap to polished aluminium 5-star base	+107
-C	Swap to hard floor castors	+0

CODE CHANGE EXAMPLES	
+ Sliding seat	ZMW-S-[FABRIC]
+ Sliding seat + Polished base	ZMW-SP-[FABRIC]
+ Sliding seat + Polished base + Hard floor castors	ZMW-SPC-[FABRIC]





# Monza Upholstered

## Upholstered task chair

DELIVERED IN  
10 DAYS 

### FEATURES

Auto synchro mech with 4 locking positions  
Fine-tune side tension adjustment

Sliding seat for seat depth adjustment (optional)

3D adjustable armrests with soft pads (optional)

Fixed armrests with adjustable soft pads (optional)  
Match frame colour

Adjustable lumbar support

Distinctive angled backrest with pattern

Black or polished 5-star base with soft floor castors

Chairs upholstered in alternative Camira fabric can normally be delivered within 14 days!



CODE	MECHANISM	EXTRAS	FINISH	FABRIC	RSP (£)
ZUB-PUK09	Automatic synchro mech with 4 locking positions	No armrests	Black frame Black base / gas lift	Camira Target Black	741
ZUBF-PUK09	Automatic synchro mech with 4 locking positions	Backrest mounted fixed height armrests with depth adjustable soft pads	Black frame Black base / gas lift	Camira Target Black	831
ZUB3-PUK09	Automatic synchro mech with 4 locking positions	Seat mounted 3D adjustable armrests with soft pads	Black frame Black base / gas lift	Camira Target Black	821

SUFFIX	OPTIONAL EXTRAS	RSP (£)
-S	Swap to sliding seat	+66
-P	Swap to polished aluminium 5-star base	+107
-C	Swap to hard floor castors	+0

CODE CHANGE EXAMPLES	
+ Sliding seat	ZUB-S-[FABRIC]
+ Sliding seat + Polished base	ZUB-SP-[FABRIC]
+ Sliding seat + Polished base + Hard floor castors	ZUB-SPC-[FABRIC]

# Monza Executive

Upholstered high back task chair



## FEATURES

Auto synchro mech with 4 locking positions  
Fine-tune side tension adjustment

Sliding seat for seat depth adjustment (optional)

3D adjustable armrests with soft pads (optional)

Fixed armrests with adjustable soft pads (optional)  
Match frame colour

Adjustable lumbar support

Distinctive angled high backrest with pattern

Black or polished 5-star base with soft floor castors

Chairs upholstered in alternative Camira fabric can normally be delivered within 14 days!

CODE	MECHANISM	EXTRAS	FINISH	FABRIC	RSP (£)
ZEB-PUK09	Automatic synchro mech with 4 locking positions	No armrests	Black frame Black base / gas lift	Camira Target Black	853
ZEBF-PUK09	Automatic synchro mech with 4 locking positions	Backrest mounted fixed height armrests with depth adjustable soft pads	Black frame Black base / gas lift	Camira Target Black	943
ZEB3-PUK09	Automatic synchro mech with 4 locking positions	Seat mounted 3D adjustable armrests with soft pads	Black frame Black base / gas lift	Camira Target Black	933

SUFFIX	OPTIONAL EXTRAS	RSP (£)
-S	Swap to sliding seat	+66
-P	Swap to polished aluminium 5-star base	+107
-C	Swap to hard floor castors	+0

CODE CHANGE EXAMPLES	
+ Sliding seat	ZEB-S-[FABRIC]
+ Sliding seat + Polished base	ZEB-SP-[FABRIC]
+ Sliding seat + Polished base + Hard floor castors	ZEB-SPC-[FABRIC]

# Verona

Mesh back task chair

DELIVERED IN  
10 DAYS 



## FEATURES

**Synchro mech with 3 locking positions**  
Front tension adjustment

**Height adjustable lumbar support**

**Rounded backrest**  
Black frame with black mesh

**Mesh backrest offers flexibility and breathability**

**Height adjustable padded armrests**

**Black or polished 5-star base with soft floor castors**

**Chairs upholstered in alternative Camira fabric can normally be delivered within 14 days!**

CODE	MECHANISM	EXTRAS	FINISH	FABRIC	RSP (£)
RMB1-PUK09	Synchronised mechanism with 3 locking positions	Height adjustable armrests	Black frame / mesh Black base / gas lift	Camira Target Black	<b>466</b>

SUFFIX	OPTIONAL EXTRAS	RSP (£)	CODE CHANGE EXAMPLES
-P	Swap to polished aluminium 5-star base	<b>+36</b>	+ Polished base <b>RMB1-P-[FABRIC]</b>
-C	Swap to hard floor castors	<b>+0</b>	+ Polished base + Hard floor castors <b>RMB1-PC-[FABRIC]</b>

BK

# Modena

Mesh back task chair

DELIVERED IN 10 DAYS 



## FEATURES

Height adjustable padded armrests

Synchro mech with 4 locking positions  
Easy to access side tension adjustment

Sliding seat for seat depth adjustment

Height adjustable backrest

Mesh backrest offers flexibility and breathability

Depth adjustable lumbar support

Distinctive Y-shape frame  
Black frame with black mesh

Black or polished 5-star base with soft floor castors

Chairs upholstered in alternative Camira fabric can normally be delivered within 14 days!

CODE	MECHANISM	EXTRAS	FINISH	FABRIC	RSP (£)
DMB1-S-PUK09	Synchronised mechanism with 4 locking positions + Sliding seat	Height adjustable armrests	Black frame / mesh Black base / gas lift	Camira Target Black	727

SUFFIX	OPTIONAL EXTRAS	RSP (£)
-P	Swap to polished aluminium 5-star base	+62
-C	Swap to hard floor castors	+0

CODE CHANGE EXAMPLES
+ Polished base <b>DMB1-SP-[FABRIC]</b>
+ Polished base + Hard floor castors <b>DMB1-SPC-[FABRIC]</b>

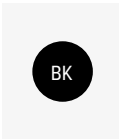

# Havana

Meeting / canteen chair

DELIVERED IN  
10 DAYS 



ACUAB-D



ACUWT-D



ACULB-D



ASUAB-D



ASULB-D

CODE	BASE	SHELL FINISH	BASE FINISH	SEAT FABRIC	RSP (€)
ACPAB-D	Metal 4-leg base	Dark Grey shell	Black legs	No seat pad	206
ACPWT-D	Wooden 4-leg base	Dark Grey shell	Beech wooden legs	No seat pad	399
ACPLB-D	Metal sled base	Dark Grey shell	Black legs	No seat pad	236
ASPAB-D	Metal 4-leg stool base	Dark Grey shell	Black legs	No seat pad	298
ASPLB-D	Metal sled stool base	Dark Grey shell	Black legs	No seat pad	309
ACUAB-D-PUK09	Metal 4-leg base	Dark Grey shell	Black legs	Camira Target Black	295
ACUWT-D-PUK09	Wooden 4-leg base	Dark Grey shell	Beech wooden legs	Camira Target Black	488
ACULB-D-PUK09	Metal sled base	Dark Grey shell	Black legs	Camira Target Black	325
ASUAB-D-PUK09	Metal 4-leg stool base	Dark Grey shell	Black legs	Camira Target Black	387
ASULB-D-PUK09	Metal sled stool base	Dark Grey shell	Black legs	Camira Target Black	398

## FEATURES

Stackable up to 6 chairs high (4-leg and sled base)

Upholstered seat pad for additional comfort (optional)

Chairs upholstered in alternative Camira fabric can normally be delivered within 14 days!

D

# Havana

Armchair / tub chair



AAUAD-D



AAUEB-D



AAUBB-D



AAUDB-D



AAUSB-D



AAUWT-D

CODE	BASE	SHELL FINISH	BASE FINISH	SEAT FABRIC	RSP (£)
AAPAD-D	Plastic 4-leg base	Dark Grey shell	Dark Grey	No seat pad	233
AAPEB-D	4-star swivel base	Dark Grey shell	Black	No seat pad	409
AAPBB-D	Pyramid with auto return	Dark Grey shell	Black	No seat pad	326
AAPDB-D	Pyramid with mini castors	Dark Grey shell	Black	No seat pad	348
AAPSB-D	5-star base with castors	Dark Grey shell	Black	No seat pad	321
AAPWT-D	Wooden 4-leg base	Dark Grey shell	Beech	No seat pad	449
AAUAD-D-PUK09	Plastic 4-leg base	Dark Grey shell	Dark Grey	Camira Target Black	328
AAUEB-D-PUK09	4-star swivel base	Dark Grey shell	Black	Camira Target Black	504
AAUBB-D-PUK09	Pyramid with auto return	Dark Grey shell	Black	Camira Target Black	421
AAUDB-D-PUK09	Pyramid with mini castors	Dark Grey shell	Black	Camira Target Black	443
AAUSB-D-PUK09	5-star base with castors	Dark Grey shell	Black	Camira Target Black	416
AAUWT-D-PUK09	Wooden 4-leg base	Dark Grey shell	Beech	Camira Target Black	544

## FEATURES

Upholstered seat pad for additional comfort (optional)

Height adjustment and tilt (swivel & 5-star bases)

Auto return feature (pyramid base with glides) ensures chair always faces forwards when not in use

Chairs upholstered in alternative Camira fabric can normally be delivered within 14 days!

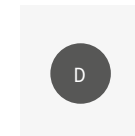

# Havana Upholstered

Armchair / tub

DELIVERED IN  
14 DAYS 



AAFA-D



AAFEB



AAFBB



AAFDB



AAFSB



AAFWT

CODE	BASE	BASE FINISH	G1 (£)	G2 (£)	G3 (£)	G4 (£)
AAFA-D	Plastic 4-leg base	Dark Grey	628	653	695	737
AAFEB	4-star swivel base	Black	804	829	871	913
AAFBB	Pyramid with auto return	Black	721	746	788	830
AAFDB	Pyramid with mini castors	Black	743	768	810	852
AAFSB	5-star base with castors	Black	716	741	783	825
AAFWT	Wooden 4-leg base	Beech	844	869	911	953

## FEATURES

Choose different fabric for shell and seat cushion



Height adjustment and tilt (swivel & 5-star bases)

Auto return feature (pyramid base with glides)  
ensures chair always faces forwards when not in use







**G1 FABRICS**

- Camira Era
- Camira Rivet 
- Camira Xtreme 

**G2 FABRICS**

- Camira Advantage
- Camira Quest 
- Camira Vita
- Camira X2 

**G3 FABRICS**

- Camira Aspect
- Camira Main Line Flax
- Camira Oceanic 
- Camira Sumi

**G4 FABRICS**

- Camira Blazer 
- Camira Synergy

# Madrid

Mesh back meeting chairs

DELIVERED IN  
10 DAYS 



## FEATURES

Cantilever base option is stackable up to 4 chairs high

Integrated armrests

Mesh backrest offers flexibility and breathability

Chairs upholstered in alternative Camira fabric can normally be delivered within 14 days!

CODE	MADRID MEETING CHAIRS	FINISH	SEAT FABRIC	RSP (£)
MMCBB-PUK09	Mesh back meeting chair, integral armrests, cantilever base	Black frame / mesh / base	Camira Target Black	465
MMEBB-PUK09	Mesh back meeting chair, integral armrests, swivel base	Black frame / mesh / base	Camira Target Black	607

BK

# Oslo

Mesh back meeting chairs

DELIVERED IN  
10 DAYS 



## FEATURES

Cantilever base option is stackable up to 4 chairs high

Integrated armrests

Mesh backrest offers flexibility and breathability

Chairs upholstered in alternative Camira fabric can normally be delivered within 14 days!

CODE	OLSO MEETING CHAIRS	FINISH	SEAT FABRIC	RSP (£)
CMS-G0	Mesh back collaborative chair with lockable tilt mechanism, tension adjustment, 5-star base with soft floor castors	Black frame / mesh Black base / gas lift	Black	267
CMC-G0	Mesh back meeting chair with cantilever base	Black frame / mesh / base	Black	246

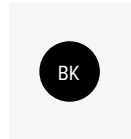

# Kardo®

Pole-mounted monitor arms

DELIVERED IN  
3-5 DAYS



CODE	KARDO	WEIGHT CAPACITY	FINISH	RSP (€)
PMA521	Pole mounted monitor arm for single screen, H400mm pole	12.5kg	White (WH) / Grey (SV) / Black (BK)	134
PMA522	Pole mounted monitor arm for twin/dual screens, H400mm pole	2 x 10kg	White (WH) / Grey (SV) / Black (BK)	200
PMA524	Pole mounted monitor arm for quad (4) screens, H700mm pole	4 x 8kg	White (WH) / Grey (SV) / Black (BK)	423
PMSA521	Tool rail mounted pole monitor arm for single screen	6kg	White (WH) / Grey (SV) / Black (BK)	131
PMAOI-521	Inverted single arm only - to convert single to twin	12.5kg	White (WH) / Grey (SV) / Black (BK)	115
LVS001	Universal laptop holder attachment / desktop stand	10kg	White (WH) / Grey (SV) / Black (BK)	67
EP550	550mm high pole		White (WH) / Grey (SV) / Black (BK)	21
EP700	700mm high pole		White (WH) / Grey (SV) / Black (BK)	23
KMC1827	Low profile mini clamp		White (WH) / Grey (SV) / Black (BK)	15

## FEATURES

Monitor arms for 1, 2 or 4 screen setups

Easy to install, no tools required

Quick release removable VESA mounting plates (75mm/100mm) slide effortlessly onto Kardo arm with fixing clips to hold screen(s) in place

Quick release height adjustment

Integrated cable management keeps the workspace clear

Includes pre-assembled hand-turn desk edge clamp plus through-desk fixing option

Low profile mini clamp option (requires hex/allen key)

Quick release universal laptop holder option

Tool rail mounted arm option for single screen display

Brighten the workspace with an integrated flower holder in the pole

Inverted single arm available to convert existing single arm to twin/dual

Certified to: BS EN ISO 9241 Workplace Ergonomics & PP 045 Safety and Durability

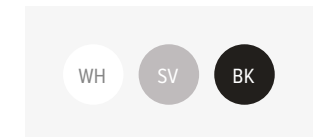

# Duro

Heavy duty monitor arms

DELIVERED IN  
3-5 DAYS 



## FEATURES

Monitor arms for 3 or 6 screen setups

Removable VESA plates

48mm pole and extra heavy duty hinged support arms

Through-desk and desk edge clamp options

Supports up to six 10kg monitors  
up to 24" in screen size\*

Certified to: BS EN ISO 9241 Workplace Ergonomics  
& PP 045 Safety and Durability

**FIRA**

CODE	DURO	WEIGHT CAPACITY	RSP (£)
PMA323	Triple screen heavy duty monitor arm	3 x 10kg	333
PMA326	Six screen heavy duty monitor arm	6 x 10kg	559

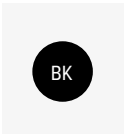

\* Maximum screen width 600mm

# Levo

Dynamic monitor arm

DELIVERED IN  
3-5 DAYS



## FEATURES

Tension adjustment indicator helps reduce project installation times

High capacity integrated cable management easily holds 4 cables

Optional 180° rotation stop

Smooth gas lift for easy height adjustment

Quick-release 75mm/100mmVESA mount with hand-turn screws

Integral high capacity cable management

Innovative connector pin makes Levo easy to reconfigure

Easy to install  
All adjustment tools included, stored inside base

Convert to laptop holder with universal VESA attachment

Optional mini CPU holder available

Tighten clamp from above desk for easy installation

Alternative through-desk clamp available

Straight twin rail attachment converts Levo arm to dual/twin screens

Easy slide adjustment to position screens  
Handle aids rail tilt adjustment

CODE	LEVO	WEIGHT CAPACITY	FINISH	RSP (£)
GMA921	Levo gas lift monitor arm for single screen/monitor*	2-10kg	White (WH) / Black (BK)	200
TSR902-BK	Levo twin rail to convert single arm to dual screens/monitors	2 x 4kg	Black (BK)	118
LVS001	Universal laptop holder attachment / desktop stand	10kg	White (WH) / Black (BK)	67
GMA9TD-BK	Alternative through-desk clamp		Black (BK)	21

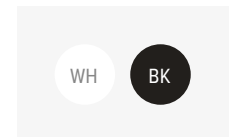

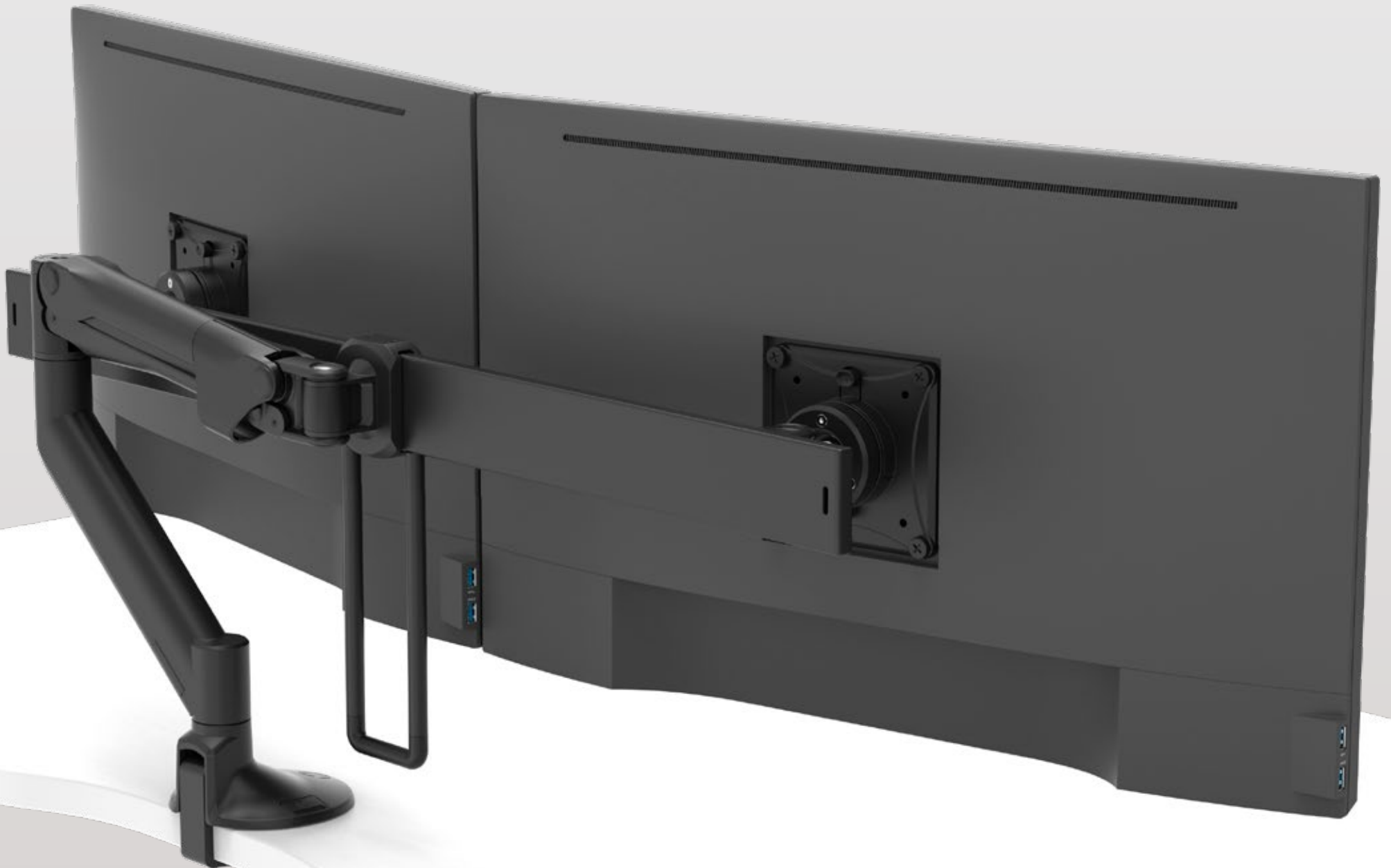

# Cable trays

DELIVERED IN  
3-5 DAYS 

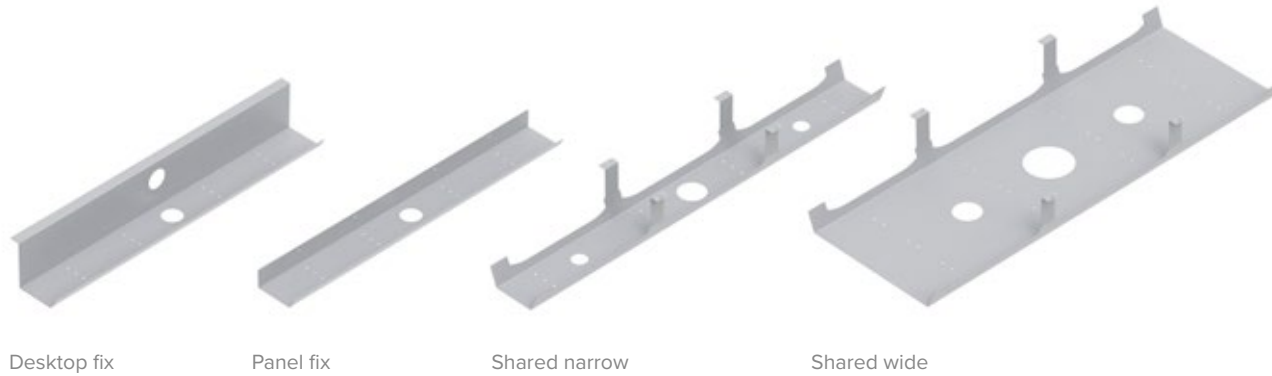

## FEATURES

Robust steel construction

Large holes for cable entry

Holes for cable ties

Match finish to desk frame

CODE	CABLE TRAYS	WIDTH	DEPTH	HEIGHT	FOR DESK WIDTH	RSP (£)
CTD060	Desktop fix tray, fixed to underside of desktop	600	100	125	1000	80
CTD100	Desktop fix tray, fixed to underside of desktop	1000	100	125	1200 / 1400	100
CTD140	Desktop fix tray, fixed to underside of desktop	1400	100	125	1600 / 1800 / 2000	120
CTM060	Panel fix tray, fixed to modesty panel	600	100	50	1000	75
CTM100	Panel fix tray, fixed to modesty panel	1000	100	50	1200 / 1400	85
CTM140	Panel fix tray, fixed to modesty panel	1400	100	50	1600 / 1800 / 2000	100
CTS100	Shared cable tray, fixed to underside of bench desktops	1000	110	130	1200 / 1400	88
CTS140	Shared cable tray, fixed to underside of bench desktops	1400	110	130	1600 / 1800 / 2000	100
CTW100	Shared cable tray, fixed to underside of bench desktops	1000	430	130	1200 / 1400	134
CTW140	Shared cable tray, fixed to underside of bench desktops	1400	430	130	1600 / 1800 / 2000	160

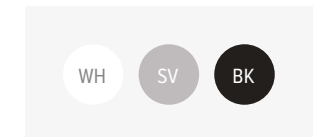



# Cable baskets

DELIVERED IN  
3-5 DAYS 

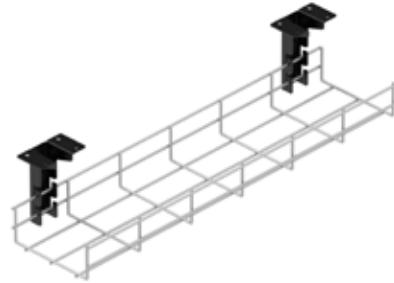

Narrow

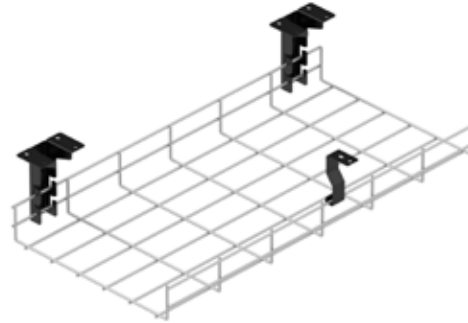

Wide

## FEATURES

Fixed to underside of desktop or modesty panel

Fixing brackets included

Baskets hinge down on brackets for easy access during installation of cables

CODE	CABLE BASKETS	WIDTH	DEPTH	HEIGHT	FOR DESK WIDTH	RSP (£)
MCB-0615-GB	Narrow, fixed to underside of desktop or modestly panel	600	150	50	1000	<b>52</b>
MCB-1015-GB	Narrow, fixed to underside of desktop or modestly panel	1000	150	50	1200 / 1400	<b>63</b>
MCB-1415-GB	Narrow, fixed to underside of desktop or modestly panel	1400	150	50	1600 / 1800 / 2000	<b>73</b>
MCB-0630-GB	Wide, fixed to underside of desktop or modestly panel	600	300	50	1000	<b>71</b>
MCB-1030-GB	Wide, fixed to underside of desktop or modestly panel	1000	300	50	1200 / 1400	<b>86</b>
MCB-1430-GB	Wide, fixed to underside of desktop or modestly panel	1400	300	50	1600 / 1800 / 2000	<b>100</b>



# Linx

Magnetic cable management spine

DELIVERED IN  
3-5 DAYS

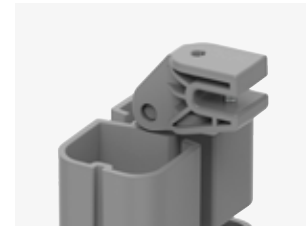

## FEATURES

Limpet magnetic fixing makes desking installation quick and easy

Mount Linx anywhere on cable tray or desk frame

Alternative multipurpose fixing clamp

Mount to cable tray, wire basket or desktop

Dual cable compartments (30mm x 25mm)

Patented 'twist not pull' linking system ensures the vertebrae will never pull apart under tension, but will detach very easily when twisted sideways

Choose from different lengths for fixed height or sit/stand desks or without the base for use between cable trays on sit/stand benches

Linx Limpet fixes the spine to cable trays or desk frame with a magnet. The spine can be easily relocated if required.

Segregated power and data cables

Large stable base

Weighted base with dual cable exits

Incredibly easy to adjust position and length and insert cables

Meets BS 6396 standard

CODE	DESCRIPTION	HEIGHT	FINISH	RSP (€)
VCS4/SDL	Magnetic cable spine for standard desk - 20 vertebrae + weighted base	800	White (WH) / Grey (SV) / Black (BK)	60
VCS4/SD	Cable spine for standard desk - 20 vertebrae + weighted base	800	White (WH) / Grey (SV) / Black (BK)	47
VCS4/HAL	Magnetic cable spine for standing desk - 33 vertebrae + weighted base	1300	White (WH) / Grey (SV) / Black (BK)	78
VCS4/HA	Cable spine for standing desk - 33 vertebrae + weighted base	1300	White (WH) / Grey (SV) / Black (BK)	65
VCS4/TTL	Magnetic cable spine for tray-to-tray use - 33 vertebrae (no base)	1280	White (WH) / Grey (SV) / Black (BK)	70
VCS4/TT	Cable spine for tray-to-tray use - 33 vertebrae (no base)	1280	White (WH) / Grey (SV) / Black (BK)	44
VCS4/HBL	Magnetic cable spines for bench with central cable tray - 66 vertebrae	-	White (WH) / Grey (SV) / Black (BK)	174
VCS4/HB	Cable spines for bench with central cable tray - 66 vertebrae	-	White (WH) / Grey (SV) / Black (BK)	112

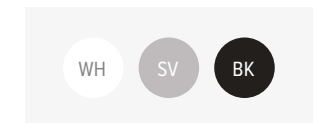

# Fabric Cable Sock

Zip-up vertical cable wrap

DELIVERED IN  
3-5 DAYS 



## FEATURES

Flexible zip design allows cables to enter at any height

Adjustable hook and loop strap provides fine height adjustment

Quick and easy to use

Made from durable 600g polyester mesh

Internal straps keep cables segregated

Ultra lightweight

Internal hook and loop straps keep power and data cables segregated

Ample cable capacity

Meets BS 6396 standard

CODE	DESCRIPTION	WIDTH	HEIGHT	FINISH	RSP (£)
VCS2	Zip-up fabric cable sock	Ø70	720 - 820	White (WH) / Black (BK)	52

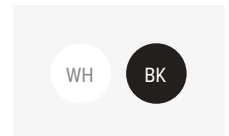

# Boost

Desktop power + data

DELIVERED IN  
3-5 DAYS



## FEATURES

USB-A & USB-C Smart Charge

RJ45 data transfer (optional)

Individually fused UK power sockets with neon master switch

High quality construction with aluminium casing

Easy-install low profile fixing clamps included  
Secure Boost to the desktop with no tools required

Easy to install. No tools required!

500mm GST 3-pole drop cable to GST 3-pole male †

Link to other under-desk, desktop or in-surface power modules, including Powerlink, Solo Plus and Click, using connector cables

[See our Daisy Chaining Guide for more information about BS 6396 regulations](#)

Fully tested and certified to BS 5733 & BS 1363-2, CE marked

CODE	DESCRIPTION	SOCKETS	USB-A	USB-C	RJ45	FINISH	RSP (£)
DPM-1P1N2C(A/C)		1	1	1	-	White (WH) / Black (BK)	113
DPM-2P1N		2	-	-	-	White (WH) / Black (BK)	75
DPM-2P1N2C(A/C)		2	1	1	-	White (WH) / Black (BK)	126
DPM-2P1N2D		2	-	-	2	White (WH) / Black (BK)	98
DPM-2P1N2D2C(A/C)		2	1	1	2	White (WH) / Black (BK)	149
DPM-4P1N2C(A/C)		4	1	1	-	White (WH) / Black (BK)	160

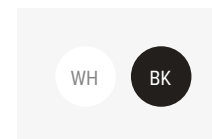

See power + data cables on page 49

# Powerlink

Under-desk power

DELIVERED IN  
3-5 DAYS

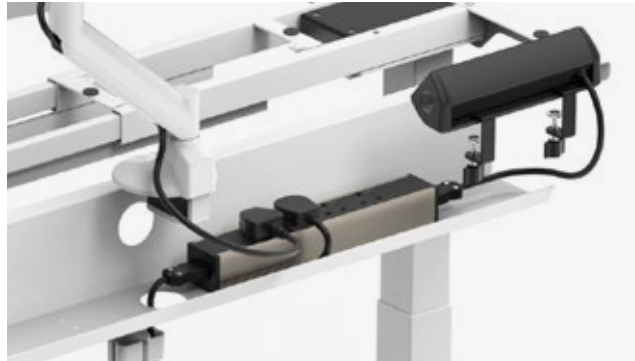

## FEATURES

High quality champagne alloy case with black plastic insert

Can be installed in cable trays or fixed to the underside of the desk using the brackets or hook & loop pads provided.

Link to other under-desk, desktop or in-surface power modules, including Boost, Solo Plus and Click, using connector cables

[See our Daisy Chaining Guide for more information about BS 6396 regulations](#)

Fully tested and certified to BS 5733 & BS 1363-2, CE marked

CODE	DESCRIPTION	SOCKETS	GST 3-POLE CONNECTOR	RSP (£)
UPMA-2P-SV	Under-desk power module	2	Male + Female	33
UPMA-3P-SV	Under-desk power module	3	Male + Female	35
UPMA-4P-SV	Under-desk power module	4	Male + Female	36
UPMA-6P-SV	Under-desk power module	6	Male only*	51



See power + data cables on page 53

\* Maximum of six power sockets in one series - see BS 6396 regulations for more information.

# Solo Plus

In-surface power + data

DELIVERED IN  
3-5 DAYS



## FEATURES

18W USB-A Quick Charge  
+ 2 x 45W USB-C Power Delivery

Compact Ø80mm module

Swappable data transfer inserts  
HDMI, RJ45, blank or leave empty  
for use as cable pass-throughs

Secure in place with clamp-on/screw-on collar from  
below or alternative securing tabs, tightened with  
screws from above

500mm GST 3-pole drop cable to GST 3-pole male <sup>†</sup>

Link to other under-desk, desktop or in-surface power  
modules, including Boost, Powerlink and Click,  
using connector cables

[See our Daisy Chaining Guide for more information  
about BS 6396 regulations](#)

Fully tested and certified to BS 5733 & BS 1363-2,  
CE & UKCA marked

CODE	POWER SOCKET	USB-A	USB-C	RJ45	HDMI	BLANK	EMPTY	FINISH	RSP (£)
S1-1P3C(1A/2C)2B	1	1	2	-	-	2	-	White (WH) / Black (BK)	152
S1-1P3C(1A/2C)2D	1	1	2	2	-	-	-	White (WH) / Black (BK)	174
S1-1P3C(1A/2C)2H	1	1	2	-	2	-	-	White (WH) / Black (BK)	174
S1-1P3C(1A/2C)1B1D	1	1	2	1	-	1	-	White (WH) / Black (BK)	163
S1-1P3C(1A/2C)1B1H	1	1	2	-	1	1	-	White (WH) / Black (BK)	163
S1-1P3C(1A/2C)1D1H	1	1	2	1	1	-	-	White (WH) / Black (BK)	174
S1-1P3C(1A/2C)1B	1	1	2	-	-	1	1	White (WH) / Black (BK)	147
S1-1P3C(1A/2C)1D	1	1	2	1	-	-	1	White (WH) / Black (BK)	158
S1-1P3C(1A/2C)1H	1	1	2	-	1	-	1	White (WH) / Black (BK)	158
S1-1P3C(1A/2C)	1	1	2	-	-	-	2	White (WH) / Black (BK)	142

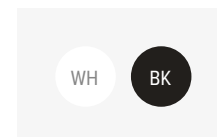

See power +  
data cables  
on page 49

<sup>†</sup> 500mm GST 3-pole male drop cables match module colour. Separate power and data cables are black only. Please contact us for power and connector cables in white. Other starter and connector cable lengths are available.



# Click

Hidden in-surface power + data

DELIVERED IN  
3-5 DAYS



## FEATURES

USB-A + USB-C Smart Charge

RJ45 & HDMI data transfer ports

Individually fused UK power sockets

Press the lid to open and reveal power sockets, charging ports and data transfer below

500mm GST 3-pole drop cable to GST 3-pole male †

Integrated GST 3-pole female connector

Split sprung lid allows cables to pass through whilst keeping all the mess covered

Link to other under-desk, desktop or in-surface power modules, including Boost, Solo Plus and Powerlink, using connector cables

[See our Daisy Chaining Guide for more information about BS 6396 regulations](#)

Fully tested and certified to BS 5733 & BS 1363-2, CE & UKCA marked

CODE	SOCKETS	USB-A	USB-C	RJ45	HDMI	FINISH	RSP (£)
APM-2P1D2C(A/C)1H	2	1	1	1	1	White (WH) / Black (BK)	338

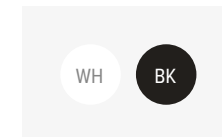

See power + data cables on page 49

† 500mm GST 3-pole male drop cables match module colour. Separate power and data cables are black only. Please contact us for power and connector cables in white. Other starter and connector cable lengths are available. Requires 275 x 164mm cut-out in surface.



# Cables

Power, connector and data cables



## FEATURES

Starter power cables are mains Type G (UK) to GST 3-pole female in black

Connector / extensions power cables are GST 3-pole male to female in black

[See our Daisy Chaining Guide for more information about BS 6396 regulations](#)

CODE	POWER CABLES*	FINISH	RSP (£)
PL-UKWF/01-BK	1m GST 3-pole starter cable	Black	19
PL-UKWF/02-BK	2m GST 3-pole starter cable	Black	19
PL-UKWF/03-BK	3m GST 3-pole starter cable	Black	23
PL-UKWF/04-BK	4m GST 3-pole starter cable	Black	28
PL-UKWF/05-BK	5m GST 3-pole starter cable	Black	31
PL-UKWF/06-BK	6m GST 3-pole starter cable	Black	41
PL-UKWF/07-BK	7m GST 3-pole starter cable	Black	44
PL-UKWF/08-BK	8m GST 3-pole starter cable	Black	48
PL-UKWF/09-BK	9m GST 3-pole starter cable	Black	52
PL-UKWF/10-BK	10m GST 3-pole starter cable	Black	57

CODE	GST SPLITTERS	FINISH	RSP (£)
PS-1M2F-BK	1 male in to 2 female out	Black	25

CODE	DATA CABLES	FINISH	RSP (£)
HL-MM/02-BK	2m HDMI cable, male to male	Black	9
HL-MM/03-BK	3m HDMI cable, male to male	Black	12
HL-MM/05-BK	5m HDMI cable, male to male	Black	17
DL-CAT6/02-BK	2m Cat6 data network cable	Black	9
DL-CAT6/03-BK	3m Cat6 data network cable	Black	12
DL-CAT6/05-BK	5m Cat6 data network cable	Black	17

CODE	CONNECTOR CABLES*	FINISH	RSP (£)
PL-WMWF/01-BK	1m GST connector cable	Black	17
PL-WMWF/02-BK	2m GST connector cable	Black	20
PL-WMWF/03-BK	3m GST connector cable	Black	28

\* 500mm GST 3-pole male drop cables match module colour. Separate power and data cables are black only. Please contact us for power and connector cables in white. Other connector/extension cable lengths are available.

# T1 CPU Holder

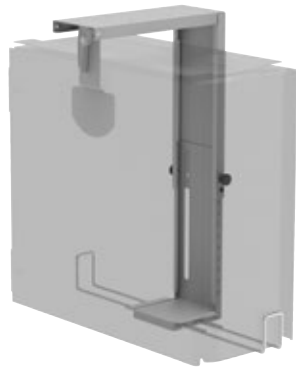

## FEATURES

Designed for mid tower CPUs, adjustable for other sizes

Spring-loaded pin to adjust height easily

Security bars prevent CPU falling from holder

Mount to desktop or side panel

Optional slide & turn kit and desk beam clearance kit

Certified to severe structural standards  
Test Method PP 050: 2009 - Severe Use



# T2 Mini CPU Holder



## FEATURES

Designed for mini tower or SFF CPUs, adjustable for other sizes

Spring-loaded pin to adjust height easily

Security bars prevent CPU falling from holder

Mount to desktop or side panel

Optional slide & turn kit and desk beam clearance kit

Certified to severe structural standards  
Test Method PP 050: 2009 - Severe Use



DELIVERED IN  
3-5 DAYS

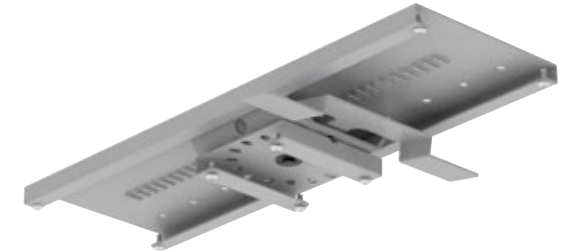

## SLIDE & TURN KIT (CHUST)

Allows easy access and repositioning of CPU

Locks in position to prevent unwanted movement

Includes desk beam clearance kit (CHSP)

Compatible with T1 & T2 CPU holders

## DESK BEAM CLEARANCE KIT (CHSP)

Enables fixing to desktop around horizontal beams

Compatible with slide & turn kit

Compatible with T1 & T2 CPU holders

CODE	DESCRIPTION	WIDTH CAPACITY	DEPTH CAPACITY	HEIGHT CAPACITY	FINISH	RSP (£)
CHF2208	T1 CPU holder	35 - 252	140 - 490	333 - 564	White (WH) / Grey (SV) / Black (BK)	108
CHF1104	T2 mini CPU holder	35 - 110	140 - 300	213 - 360	White (WH) / Grey (SV) / Black (BK)	74
CHUST	Slide & turn kit for T1 & T2 (includes CHSP)				White (WH) / Grey (SV) / Black (BK)	57
CHSP	Desk beam clearance kit for T1 & T2				White (WH) / Grey (SV) / Black (BK)	10

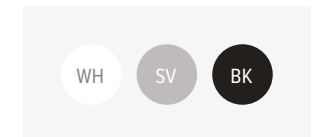

# S1 Mini CPU Holder



## FEATURES

Designed for mini CPUs or thin clients

Ideal for Apple Mac Mini®

Adjustable security strap with side release buckle

Mount to VESA or monitor arm pole

Compatible with Metalicon® Kardo®, Levo and Duro monitor arms

# Laptop Desk Stand



## FEATURES

Designed to raise any laptop off the work surface

Mount to Metalicon® monitor arms with VESA fixings  
75/100mm VESA compatible

Soft touch pads protect laptop case

Vents prevent laptop from overheating

Secure laptop in place with gentle clamps

Works with almost any laptop

Surface



Compatible with Kardo



Compatible with Levo



CODE	DESCRIPTION	WIDTH CAPACITY	DEPTH CAPACITY	HEIGHT CAPACITY	FINISH	RSP (€)
CHV1002	S1 CPU holder for mini CPUs or thin clients, compatible with Metalicon® monitor arms				White (WH) / Grey (SV) / Black (BK)	40
LVS001	Universal laptop desk stand / holder, compatible with Levo and Kardo monitor arms				White (WH) / Grey (SV) / Black (BK)	67

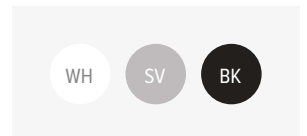

v5.0



Work happy.®  
Work well.

Compass House  
Waveney Drive  
Lowestoft, NR33 0TP

+44 (0)1502 533 433  
sales@arrowgroup.com

[arrowgroup.com](http://arrowgroup.com)

Certified for ISO 9001 Quality Management Systems  
and ISO 14001 Environmental Management